



















## ANTENNAS | MIMO-3-13 SERIES

# 3-IN-1 TRANSPORTATION & AUTOMOTIVE ANTENNA

410 - 3800 MHz; 2X2 LTE (MIMO), 5.8 dBi; GPS/GLONASS, 21 dBi



							 Urban		
410 – 470 MHz; 698 – 2700 MHz; 3400 – 3800 MHz	LTE: 5.8 dBi; GPS: 21 dBi	Increase x Mb/s	Omni- Directional	410 – 470 MHz	4G LTE	5G Ready		 Rural/Farm	
									 Marine
2X2 MIMO	IP 68	Chemical Protection	Machine to Machine	GPS Included -40°C to +80°C					
							APPLICATION AREAS		
3.5 GHz CBRS Band									

- **3-in-1 High performance multi frequency 2G/3G/4G/LTE antenna (5G Ready)**
- **2X2 MIMO LTE & GPS / GLONASS**
- **Ultra-wideband, includes 450 MHz and 3.5 GHz CBRS bands**
- **Robust and water-resistant antenna (IP 68)**
- **Ideal for transportation and marine use**
- **Multi mounting options for easy installation**

## Product Overview

The MIMO-3-13 is a 3-in-1 high performance multi frequency antenna within a single housing, providing two cellular and a GPS/GLONASS antenna. The two cellular MIMO antennas (for 2G/3G/4G) covers the contemporary 698 MHz to 2700 MHz bands, as well as the new emerging LTE and 5G spectrum for 450MHz and 3.5GHz CBRS bands, which is becoming popular across the various international cellular network operators for LTE. The ultra-wideband performance of the antenna allows it to be used across different operators and technologies and is ready for future cellular technologies up to 3.8 GHz for 5G applications. The third antenna is a high-performance active GPS/GLONASS system operating down to -40°C. The MIMO-3-13 exceeds the performance of most competitors due to the attention to the design of this high-performance antenna. The radiation patterns of all radiating elements provide an excellent balance between omnidirectionality, pattern diversity and good radiation abilities at the desired elevation. This is an important criterion for the transportation and marine market, which the antenna was specifically designed for. Main applications are for commercial/industrial vehicles, marine, M2M and other IoT systems using a wide range of radio technologies, while remaining futureproof over the wide frequency band.

## Features

- Ultra-wideband from 410 to 470 MHz, 698 to 2700 MHz and 3400 to 3800 MHz bands.
- Cleverly designed decorrelated antennas give superior MIMO performance in the cellular bands
- Above features maintained from 698 to 5800 MHz in relevant bands, including the 450 MHz
- Includes high-performance GPS/GLONASS antenna
- Careful mechanical design provides ruggedness, corrosion, water, dust resistance (IP 68)
- Ground plane independent: MIMO-3 is designed with an internal ground plane, making the antenna suitable for implementation on all surface types.

## Application Areas

- Transport broadband, automation and telemetry for busses, utility, trucking and public safety vehicles
- Industrial factory automation, robotic machinery and other M2M systems telemetry
- Farming & agricultural automation such as M2M & IoT
- Broadband cellular distribution for marine / boats (inland and near coastal vessels)
- Mining vehicles and machinery communications, telemetry and automation (M2M & IoT)



### Frequency Bands

The MIMO-3-13 is a wide-band antenna that works from | 410-470 MHz | 698-960 MHz | 1710-2700 MHz | 3400-3800 MHz | and the following Wi-Fi frequency bands | 2400-2500 MHz |

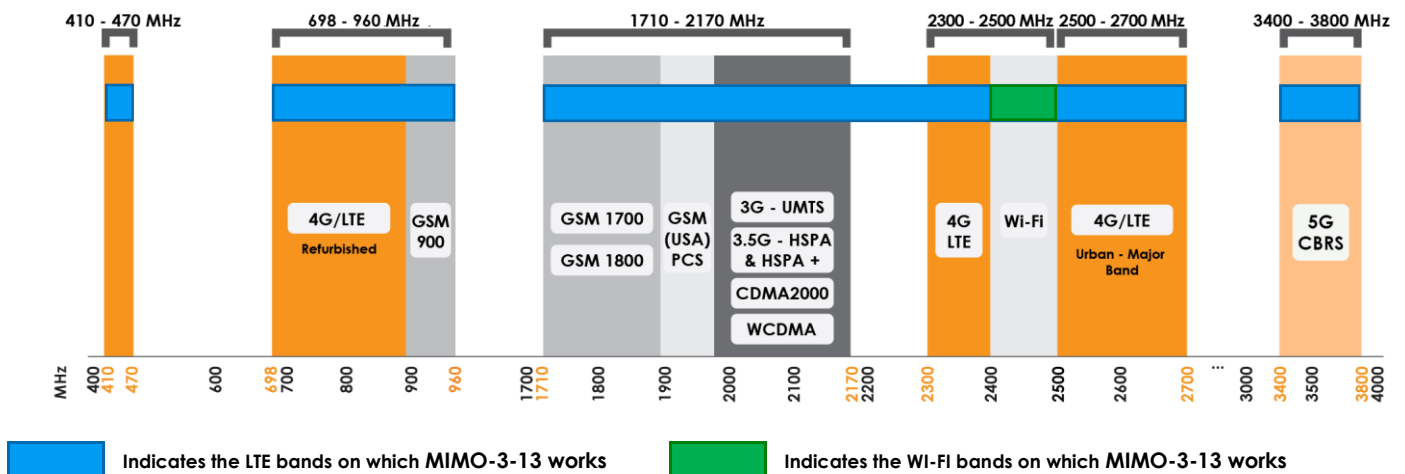

### Antenna Overview

Ports	1 & 2	3
SISO / MIMO	2x2 MIMO	N/A
Frequency Bands	410 - 3800 MHz	1575.42 MHz/1600 MHz
Peak Gain	5.8 dBi	21 dBi
Coax Cable Type	Twin HDF 195	RTK-031
Coax Cable Length	2m	2m
Connector Type	SMA (M)	SMA (M)

\*The coax cables & connectors are factory mounted to the antenna

## Electrical Specifications - Cellular

Frequency bands:	410-470 MHz 698-960 MHz 1710-2700 MHz 3400-3800 MHz
Gain (max) Port 1 & 2:	1 dBi @ 410-470 MHz 3.5 dBi @ 698-960 MHz 5.8 dBi @ 1710-2700 MHz 4 dBi @ 3400-3800 MHz
VSWR Port 1 & 2:	≤ 2.5:1 across 90% of the bands
Feed power handling:	10 W
Input impedance:	50 Ohm (nominal)
Polarisation:	Linear Vertical
Coax cable loss:	0.232 dB/m @ 400 MHz 0.362 dB/m @ 900 MHz 0.514 dB/m @ 1800 MHz 0.533 dB/m @ 2400 MHz 0.603 dB/m @ 3000 MHz
Path to Ground:	Yes

## GPS/Glonass Antenna Electrical Specifications

Frequency Range (GPS):	1575.42MHz/1600MHz
Gain (Max):	21+/-2dBi
VSWR:	≤1.5:1
DC Voltage:	2.7-3.3 V
DC Current:	5-15mA
Noise Figure:	≤1.5 dB
Nominal Impedance:	50 Ω
Polarisation:	RHCP
Filter Out Band Attenuation:	12dB Min f0+50MHz, 16dBi Min f0-50MHz
Voltage:	2.7 - 3.3V
Max. Power:	50 W
Coax cable loss:	0.71 dB/m @ 1500 MHz

## Product Box Contents

Antenna:	A-MIMO-0003-V2-13
Mounting bracket:	Threaded Spigots (Up to 60mm clamping thickness), Adhesive Surface Mounting & Optional Magnetic Mount

## Ordering Information

Commercial name:	MIMO-3-V2-13
Order product code:	A-MIMO-0003-V2-13
EAN number:	0707273470287

## Mechanical Specifications

Product dimensions	253 mm x 128 mm x 144 mm
Packaged dimensions:	265 mm x 211 mm x 204 mm
Weight:	1.2 kg
Packaged weight:	1.31 kg
Radome material:	UV Stable ASA
Radome colour:	Brilliant White Pantone P 179-1 C
Mounting Type:	Spigot, Surface, and Magnetic mount options

## Environmental Specifications, Certification & Approvals

Wind Survival:	≤220 km/h
Temperature Range (Operating):	-40°C to +80°C
Environmental Conditions:	Outdoor/Indoor
Water ingress protection ratio/standard:	IP 68
Salt Spray:	MIL-STD 810F/ASTM B117
Operating Relative Humidity:	Up to 98%
Storage Humidity:	5% to 95% - non-condensing
Storage Temperature:	-40°C to +80°C
Enclosure Flammability Rating:	UL 94-HB
Impact resistance:	IK 10
Product Safety & Environmental:	Complies with CE and RoHS standards

**Antenna Performance Plots**

**VSWR: Cellular Antenna**

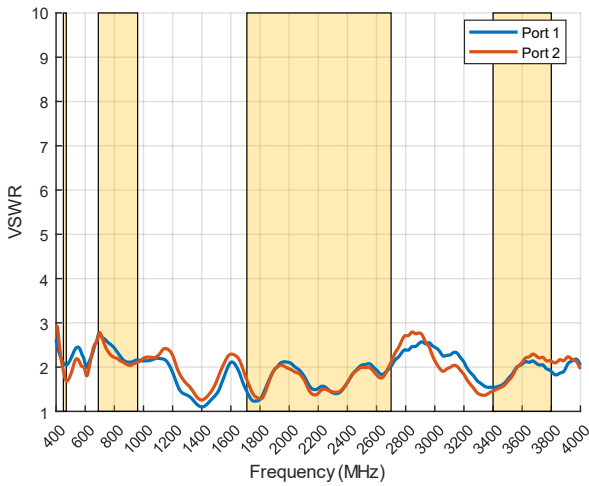

**Gain: Cellular Antenna**

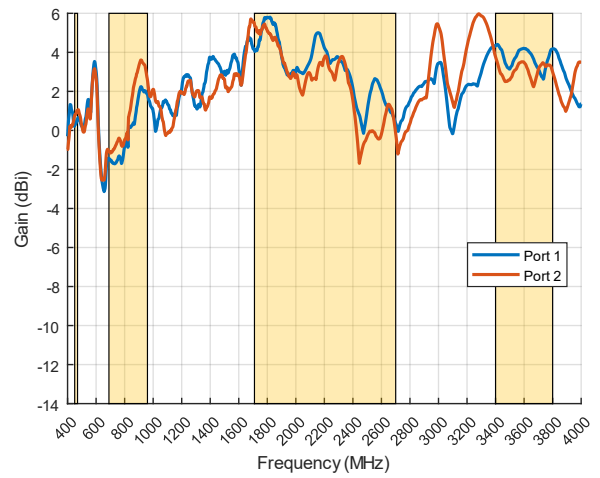

**Voltage Standing Wave Ratio (VSWR)\***

VSWR is a measure of how efficiently radio-frequency power is transmitted from a power source, through a transmission line, into a load. In an ideal system, 100% of the energy is transmitted which corresponds to a VSWR of 1:1.

The MIMO-3-13 delivers superior performance across all bands with a VSWR of  $\leq 2.5:1$  across 90% of the band

\*Measured with 2m low loss cable, 650 x 650 mm ground plane, and unused ports terminated with 50Ω load.

**Gain in dBi**

5.8 dBi is the peak gain across all bands from 410 -3800 MHz

Gain @ 410-470 MHz:	1 dBi
Gain @ 698-960 MHz:	3.5 dBi
Gain @ 1710-2700 MHz:	5.8 dBi
Gain @ 3400-3800 MHz:	4 dBi

**Technical Drawings**

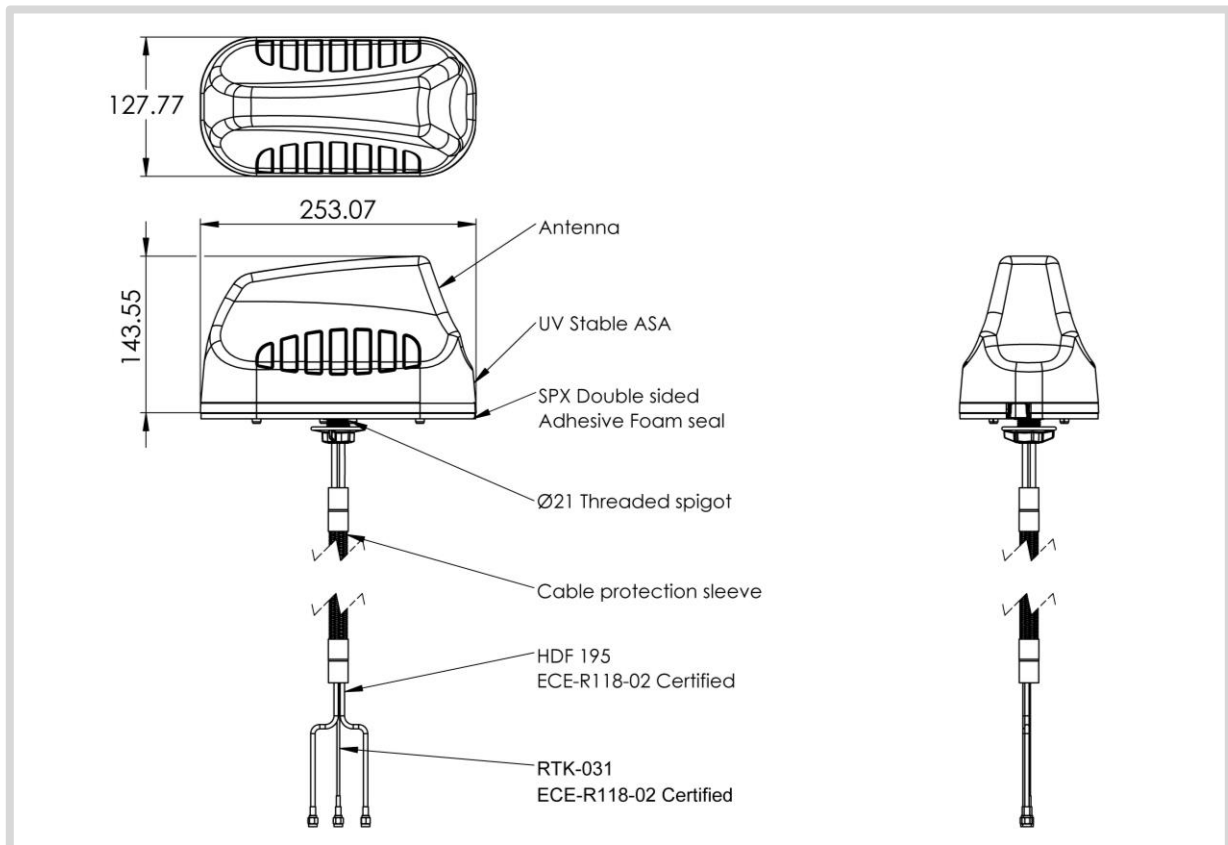

**Radiation Patterns – Cellular**

Azimuth (Top View): 410–470 MHz

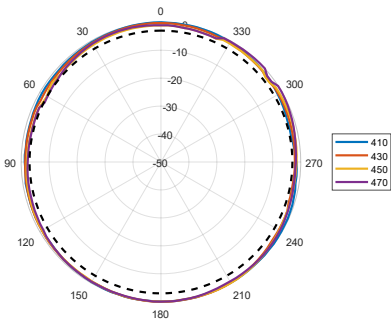

Azimuth (Top View): 698–960 MHz

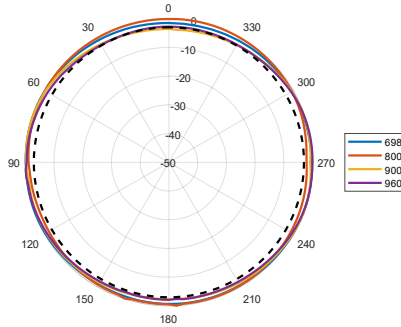

Azimuth (Top View): 1710–2100 MHz

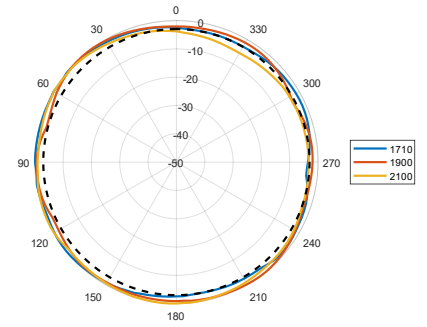

Azimuth (Top View): 2300–2700 MHz

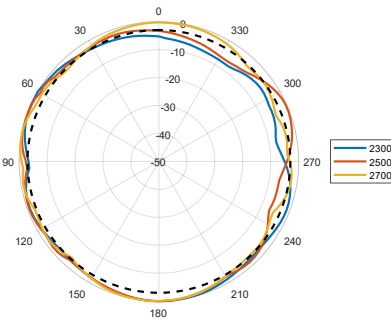

Azimuth (Top View): 3400–3800 MHz

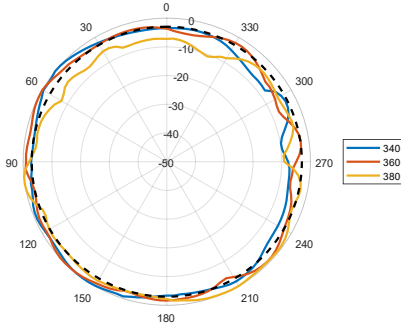

Elevation1 (Side View): 410–470 MHz

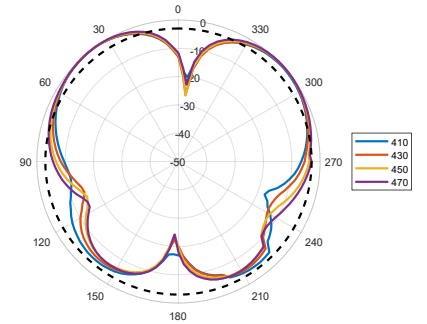

Elevation1 (Side View): 698–960 MHz

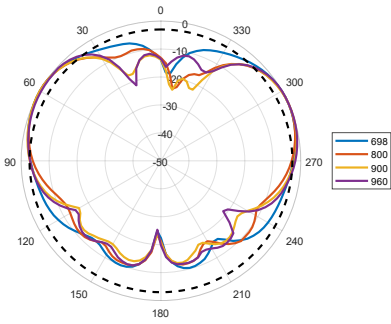

Elevation1 (Side View): 1710–2100 MHz

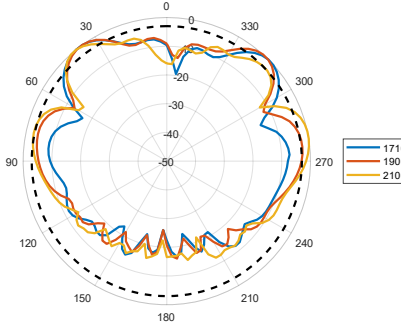

Elevation1 (Side View): 2300–2700 MHz

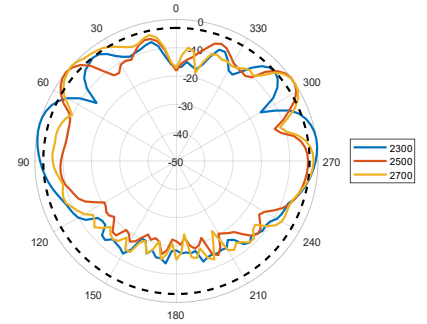

Elevation1 (Side View): 3400–3800 MHz

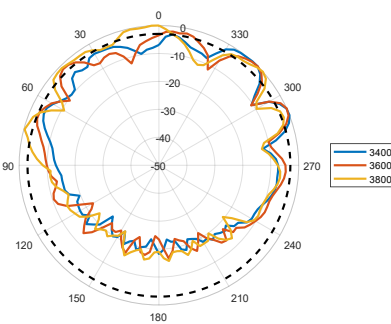

Elevation2 (Side View): 410–470 MHz

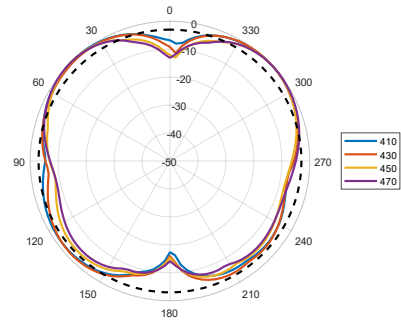

Elevation2 (Side View): 698–960 MHz

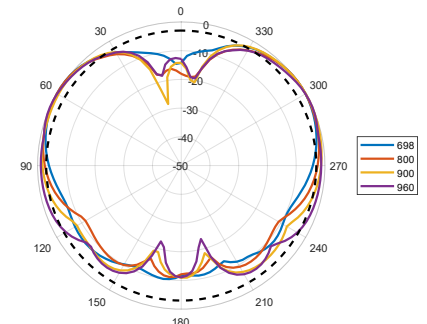

Elevation2 (Side View): 1710–2100 MHz

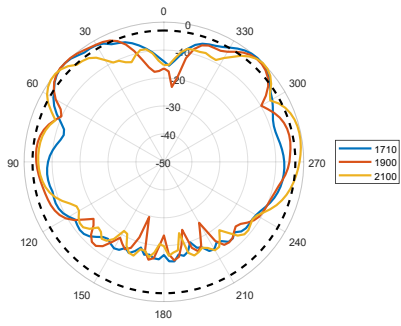

Elevation2 (Side View): 2300–2700 MHz

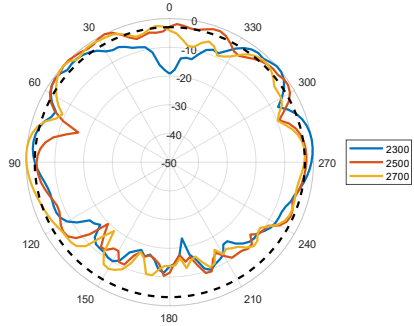

Elevation2 (Side View): 3400–3800 MHz

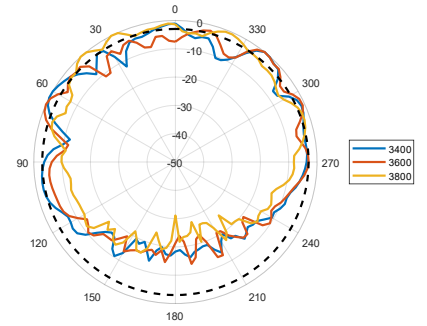

**Radiation Patterns – GPS**

XY Plane: 1561–1602 MHz

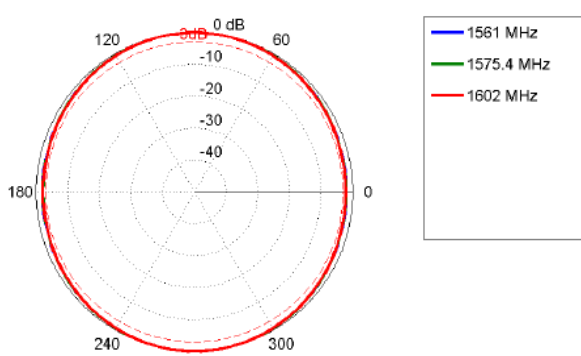

XZ Plane: 1561–1602 MHz

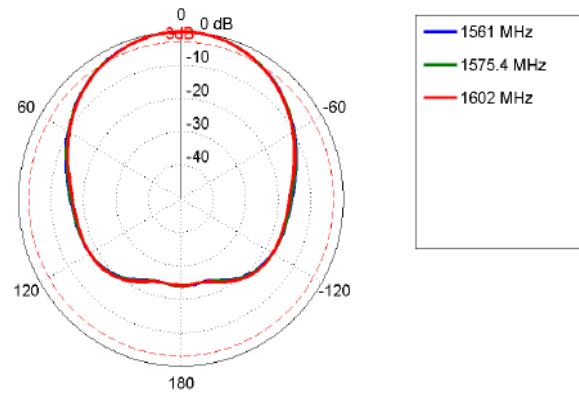

YZ Plane: 1561–1602 MHz

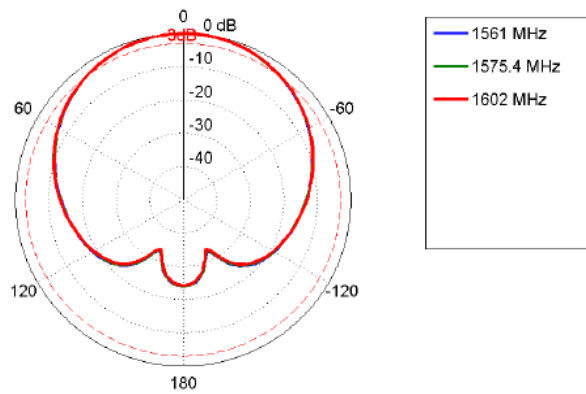

**Mounting Options**

**Standard Spigot Mount**

Threaded Spigot Mounting

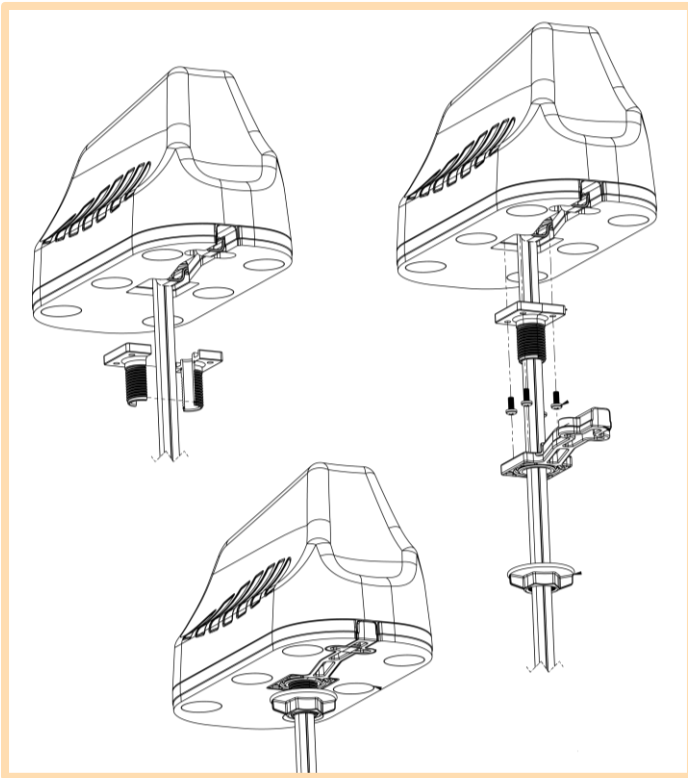

**Surface Mount**

Adhesive Surface Mounting

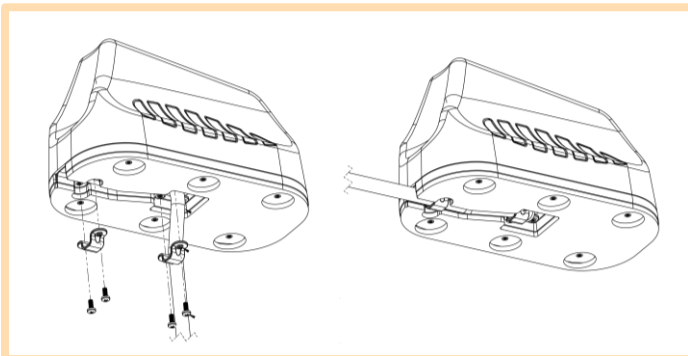

**Magnetic Mount**

Optional Magnetic Base Kit

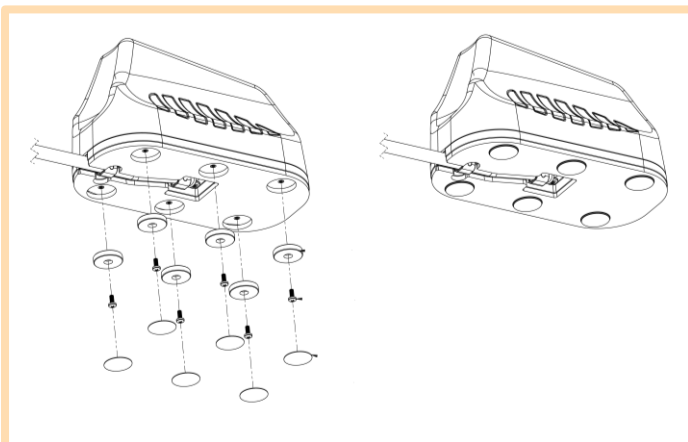

---

## Additional Accessories



**A-MBK-0001-V1.0**

Magnetic Base Kit



**Various Cable Extensions Available**

---

## Contact Poynting

### **Poynting Antennas (Pty) Ltd - Head Office**

Unit 4, N1 Industrial Park  
Landmarks Avenue,  
Samrand, 0157  
South Africa

**Phone:** +27 (0) 12 657 0050

**E-mail:** sales@poynting.co.za

### **Poynting Europe**

Regus Business Center Neue Messe Riem  
Kronstadter Straße 4  
81677 München  
Germany

**Phone:** +49 89 208026538

**E-mail:** sales-europe@poynting.tech